



KIP 720

CIS SCANNING SYSTEM



KIP 720 SCANNING SYSTEM

KIP 720 Image Scanner

The KIP 720 colour & monochrome scanner delivers large-format scanning and copying functionality with world-class scanning speeds and unbeatable image accuracy.

The KIP 720 large format scanner is a 24-bit, 914mm wide full-colour image capture system perfect for processing photographs, complex maps, and AEC/ CAD drawings. The KIP 720 scanner provides unparalleled scanning speeds of 7.6m/min (monochrome) and 3m/min (full-colour) when scanning at 300 dpi.

Benefits of CIS Scanning

Technology Sharp Image Scanning

The KIP 720 CIS (Contact Image Sensor) technology scanning method enables high resolution, high speed image capture with energy saving operation in a light, compact and portable design.

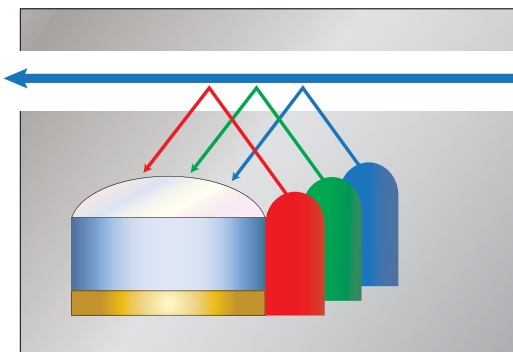

CIS technology features a series of Red, Green and Blue lights that illuminate in turn to capture image data related to each colour.

Key Features

- **914mm Wide**
- **Face-up document scanning**
- **True 600x600 dpi optical resolution**
- **CIS scanning technology provides high definition scans**
- **Real Time Thresholding Technology (RTT)**
- **No folded optics—No warm-up time**
- **Scan speeds up to 7.6mm (B/W) & 3m/min (full colour) at 300dpi**
- **0.1% scanning accuracy**
- **High resolution, high speed user-friendly operation with smart energy usage for maximum environmental conscientiousness**
- **High Definition scanning that advances graphical image capture possibilities**

Advanced RTT Technology



KIP's Real Time Thresholding technology automatically optimises background levels for each original, creating smooth reproductions of halftone gradients. KIP RTT technology automatically adjusts the threshold levels on a standard A1 size document over half a million times per scan!





Full Colour Workflow Integration

The KIP 720 stand alone scanner system provides accurate, professional results based on true 600 dpi optical resolution and 24-bit colour imaging technology. Scan full colour technical documents, maps, posters and photos into a variety of file formats for E-mail, archive and print purposes.

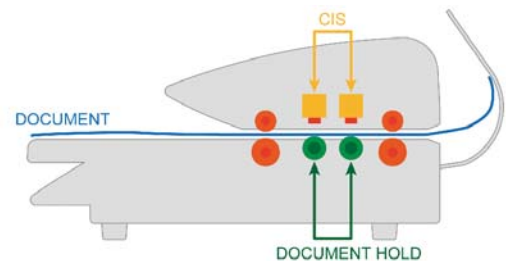

A specialised support system under the document enhances feed reliability.

Productive:

- High-speed, high-resolution CIS document image capture
- 4.5 seconds monochrome A1 Size
- 14 seconds colour A1 Size

Quality:

- High-resolution, 600dpi scanning
- 24-Bit colour depth

Responsive:

- Ready in less than 10 seconds

Earth Concious:

- Compact & Lightweight
- Compatible with Energy Star program & RoHS
- Scans recycled medias

SYSTEM
SOFTWARE



KIP 720 / 2300 Stand Alone Scan Station

KIP ImagePro – Scan & Copy

KIP ImagePro – Scan & Copy software is the professional's choice for wide format production Scan & Copy providing a complete set of features for high resolution colour and B&W copying & scan-to-file applications. For exclusive use with the KIP 720 and KIP 2300 scanners.

KIP ImagePro tools are designed to enhance colour management capabilities. KIP ImagePro offers extensive features for increased productivity including image quality adjustments, high definition viewer with advanced Area of Interest functions, auto document width detection along with Auto Start for stream feeding originals, scan to local drives, LAN locations, USB and cloud storage.

Simplify document quality when scanning or copying difficult originals by selecting b&w point settings on-the-fly adjustments to quickly snap text to solid black or to clean up back ground. Des skew documents automatically. Sophisticated project details can be highlighted with Advanced Area of Interest selections. KIP Smart Stack simplifies the accurate collation of mixed sets of colour and black and whites prints. The professional colour editor included with KIP ImagePro offers a high definition colour editor with real time colour correction viewing. Create impressive vibrant colour impact for posters, banners, point of purchase, business communications, safety, and technical images. Streamline colour correction with colour exchange selections from a choice of multiple colour spaces for optimal results.

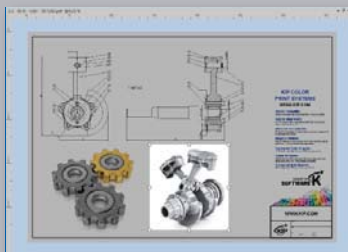

Area of Interest (AOI)

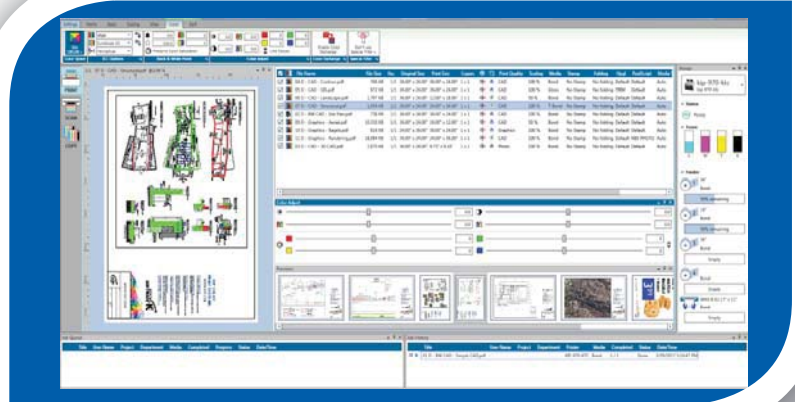

Matrix Scan & Copy with HD Viewer, "Pop out" Panels & Device Status

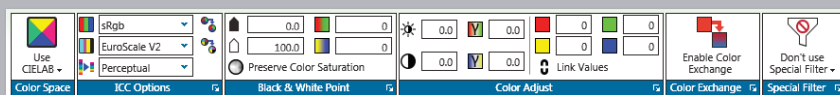

Professional Colour Management

KIP ImagePro Key Features



Auto Start for Stream Feed Productivity | Auto Width Detection | Auto Deskew | Auto Increment of File Name | Advanced Area of Interest Selection | Professional Colour Editor & Correction Features | KIP Smart Stacking | High Definition Viewing | Customisable Interface for Personalised View

KIP ImagePro – Scan & Copy Feature Descriptions



File Renaming Mode

Rapidly rename hundreds of files with KIP's file renaming tool. Batch scan using production file naming conventions and rename the files post scanning. Use KIP's HD Viewer to zoom in and lock onto the title block area. Enter a new name and press enter to auto zoom to the same location on the next file.



Image Navigator

Within the KIP High Definition viewer, quickly navigate long length images or jump to any position with the Image Navigator. The repositionable thumbnail displays the current location on the zoomed in image. Set the location of the thumbnail view in any of the four corners. Select any new location or drag the Navigator box to change locations.



Stream Feeding Productivity

Auto Start for continuous original document feeding for maximum productivity | Auto De-skew | Auto Width Detection | Auto File Name Increment | Auto Length Detection | Live Preview



Advanced Area of Interest

Select Size | Position | Save only the "area of interest" to enhance communication of sophisticated or important details



Professional Colour Editor & Correction Features

High definition colour editor with real time colour correction viewing to create impressive vibrant colour impact for posters, banners, point of purchase, business communications, safety, and technical images. Streamlines colour correction with colour exchange selections from a choice of multiple colour spaces for optimal results.



High Definition Viewing

High resolution image pre-flight viewer to include review of colour adjustments and preset creations | Colour or B&W | AOI Selection - Scale, Position, Print | Page ruler | View Scale to Pixels or In-Screen



Customisable Interface for Personalised View

Access your preferred productivity features with ease using "Pop Out" tools and panels



Scan Mode

B&W, Grayscale & Colour Scan to File | Scan to Local Drive, USB, LAN or Cloud locations | Wide Variety of File Formats | Scan to Multi-Page PDF and TIF | Set Image Compression | Utilise Templates | Embed Stamps | Control Margins | Mirror and Rotation



Copy Mode

Copy to KIP System K B&W and Colour Systems | B&W, Grayscale and Colour Adjustments | Save Unlimited Presets and Template | Secure Printing | Use Set Separation pages | KIP Accounting Integration | KIP Cost Center Integration

KIP 720 SPACE REQUIREMENTS

KIP 720 Scanning System Space Requirements

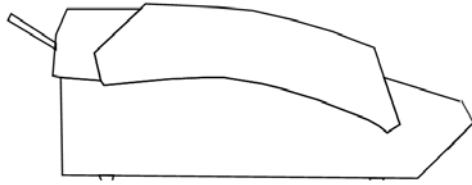

KIP 720 Side View



KIP 720 Front View

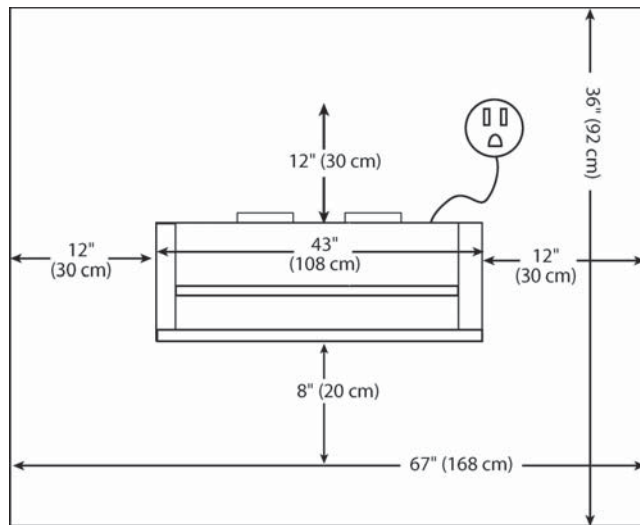

KIP 720 Top View

KIP 720 SPECIFICATIONS



General Specifications

| | |
|--|---|
| Scanner Type | C.I.S. with KIP RTT Technology |
| Scan Resolution | 600 x 600 dpi optical resolution |
| Scan Speed | Scanning speed (600 dpi), Monochrome : 65mm/s, Grayscale : 65mm/s, Color : 22mm/s |
| Scan Format | TIFF, Multipage TIFF, PDF, PDF-A, Multipage PDF, DWF, Multipage DWF, JPEG, CALS |
| Scan Destination | Local USB(Removable Media), Unlimited IPS Mailboxes(Local), Unlimited FTP, Unlimited SMB |
| Original Size Width | 279 - 914 mm |
| Original Thickness | Up to 1.6mm thick |
| Interface | USB 2.0 |
| Dimensions | 1,092 mm x 406 mm x 170 mm |
| Weight | 25 Kg |
| Electrical | 100-240V AC 50/60 Hz |
| Power Consumption | <50 W |
| Minimum PC Requirements (NOT INCLUDED WITH SCANNER) | <p>Intel Pentium G630 2.7 GHz or faster</p> <p>Windows 7/10, 32 or 64 Bit operating system</p> <p>250 Gb or larger, (free space) SATA Hard Disk Drive <i>(Example: 100 colour or 300 mono A1 Size images in a large set would require up to 5 Gb)</i></p> <p>4 Gb DDR SDRAM</p> <p>DVD Optical Drive (ROM)</p> <p>27" wide screen flat panel monitor</p> <p>Integrated Intel Video</p> <p>Network adapter – Integrated 100/1000 Ethernet LAN. <i>(Wireless is not recommended due to file transfers during copy process)</i></p> <p>One available USB 2.0 port or higher</p> <p>Standard USB Keyboard and USB Mouse</p> |



www.kip.com

KIP is a registered trademark of the KIP Group. All other product names mentioned herein are trademarks of their respective companies.

All product features and specifications are subject to change without notice. Complete product specifications are available upon request. © 2018